

■ **Specifications**

- Contact resistance: $\leq 20\text{m}\Omega$
- Insulation resistance: $\geq 1000\text{M}\Omega$
- Rated voltage: 250V AC DC
- Rated current: 2.0A AC DC
- Withstand Voltage: 1000V AC/minute
- Temperature Range: $-40^{\circ}\text{C} \sim +105^{\circ}\text{C}$

■ **Assembly Layout**

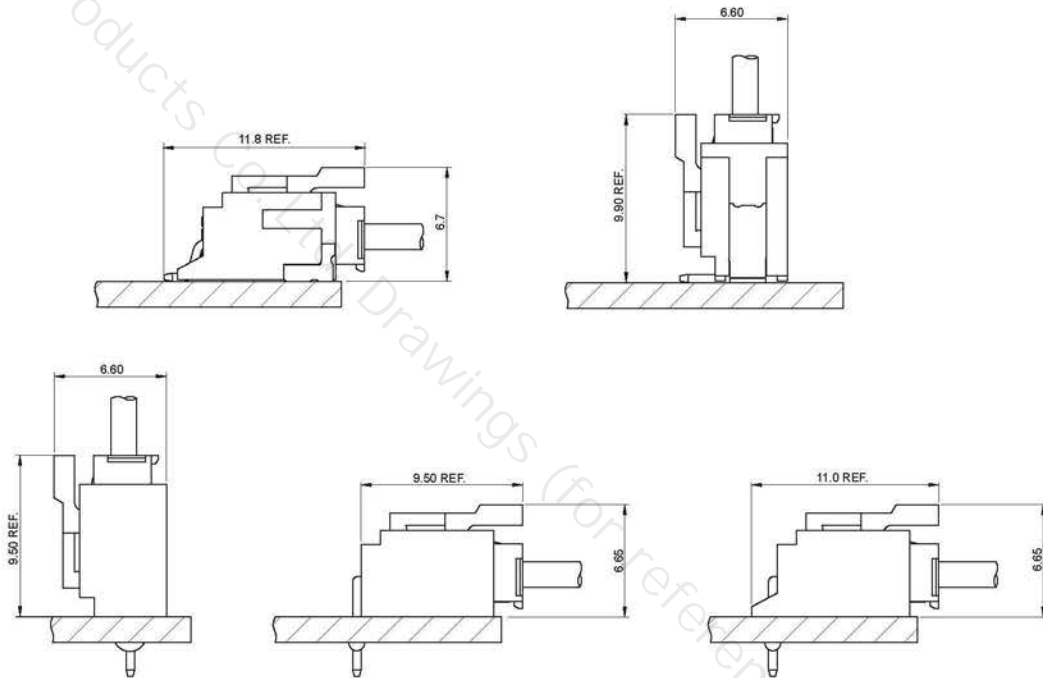

A2002AWR (2.00mm pitch 90°Wafer SMT TYPE)

- Reference Information:
- Material: Pin: Brass/Tin-plated
- Solder Tabs: Brass/Tin-plated
- Wafer: LCP,UL94V-0
- Mates with A2002 series Housing

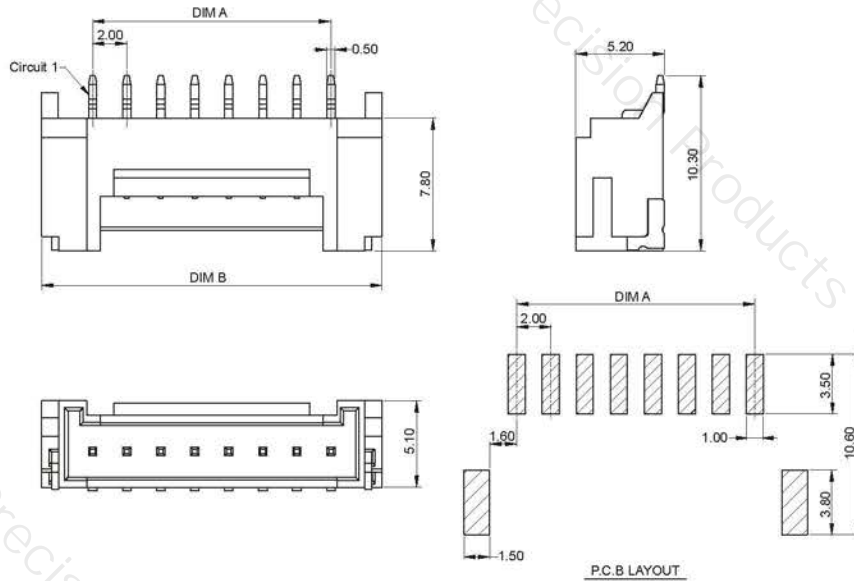
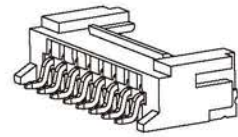

Ordering Information & Dimensions:

Circuit	Dimensions(mm)	
	A	B
02	2.00	8.00
03	4.00	10.00
04	6.00	12.00
05	8.00	14.00
06	10.00	16.00
07	12.00	18.00
08	14.00	20.00
09	16.00	22.00
10	18.00	24.00
11	20.00	26.00
12	22.00	28.00
13	24.00	30.00
14	26.00	32.00
15	28.00	34.00
16	30.00	36.00

A2002AWV (2.00mm pitch 180°Wafer SMT TYPE)

- Reference Information:
- Material: Pin: Brass/Tin-plated
- Solder Tabs: Phosphor Bronze/Tin-plated
- Wafer: LCP,UL94V-0
- Mates with A2002 series Housing

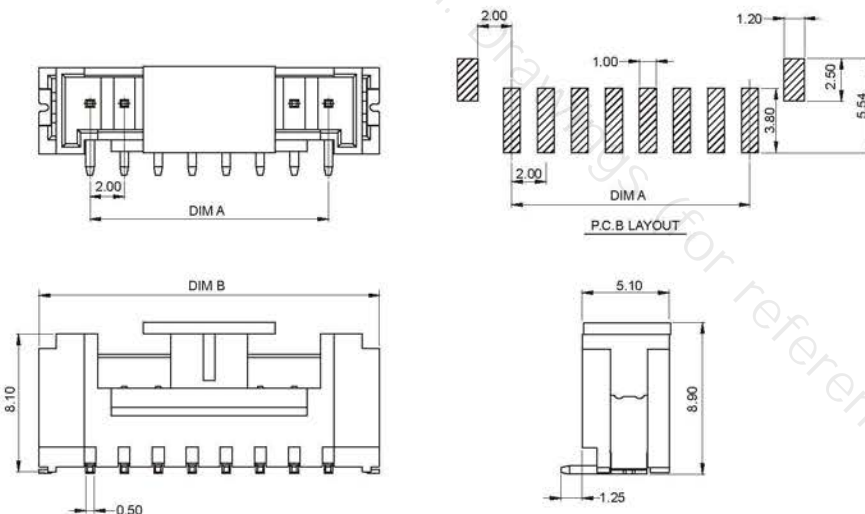
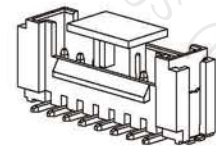

Ordering Information & Dimensions:

Circuit	Dimensions(mm)	
	A	B
02	2.00	8.00
03	4.00	10.00
04	6.00	12.00
05	8.00	14.00
06	10.00	16.00
07	12.00	18.00
08	14.00	20.00
09	16.00	22.00
10	18.00	24.00
11	20.00	26.00
12	22.00	28.00
13	24.00	30.00
14	26.00	32.00
15	28.00	34.00
16	30.00	36.00

A2002 SERIES

2.00mm pitch wire to board connector

A2002A (2.00mm pitch 180°Wafer DIP TYPE)

- Reference Information:
- Material: Pin: Brass/Tin-plated
- Wafer: PA66,UL94V-0(2)
- Mates with A2002 series Housing

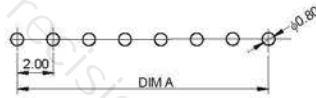
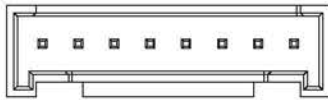
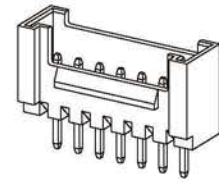

P.C.B LAYOUT

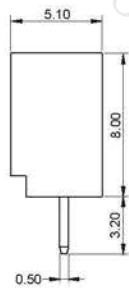
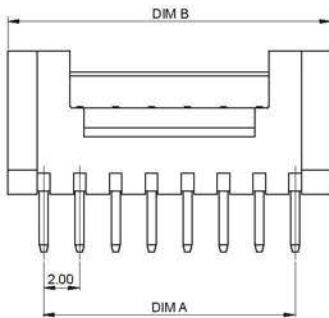

Ordering Information & Dimensions:

Circuit	Dimensions(mm)	
	A	B
02	2.00	6.00
03	4.00	8.00
04	6.00	10.00
05	8.00	12.00
06	10.00	14.00
07	12.00	16.00
08	14.00	18.00
09	16.00	20.00
10	18.00	22.00
11	20.00	24.00
12	22.00	26.00
13	24.00	28.00
14	26.00	30.00
15	28.00	32.00
16	30.00	34.00

A2002AW (2.00mm pitch 90°Wafer DIP TYPE)

- Reference Information:
- Material: Pin: Brass/Tin-plated
- Wafer: PA66,UL94V-0(2)
- Mates with A2002 series Housing

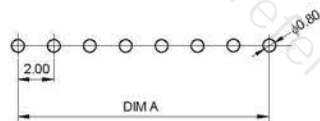
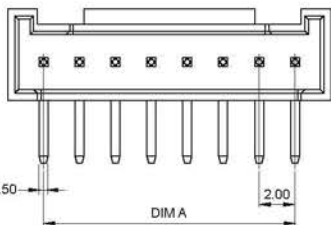
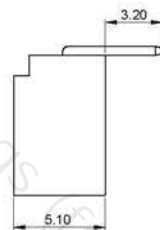
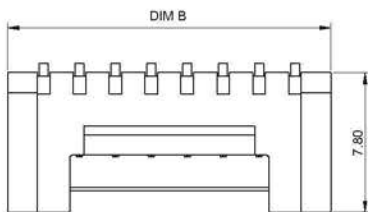
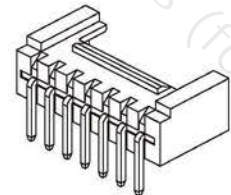

P.C.B LAYOUT

Ordering Information & Dimensions:

Circuit	Dimensions(mm)	
	A	B
02	2.00	6.00
03	4.00	8.00
04	6.00	10.00
05	8.00	12.00
06	10.00	14.00
07	12.00	16.00
08	14.00	18.00
09	16.00	20.00
10	18.00	22.00
11	20.00	24.00
12	22.00	26.00
13	24.00	28.00
14	26.00	30.00
15	28.00	32.00
16	30.00	34.00

A2002 SERIES

2.00mm pitch wire to board connector

A2002AWD (2.00mm pitch 90°Wafer DIP TYPE)

- Reference Information:
 - Material: Pin: Brass/Tin-plated
 - Wafer: PA66,UL94V-0(2)
 - Mates with A2002 series Housing

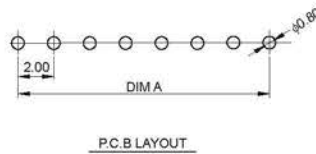
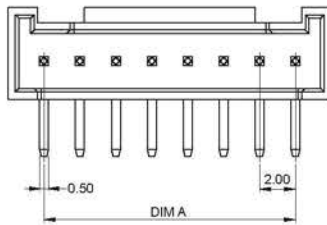
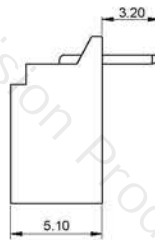
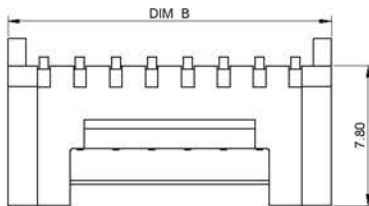
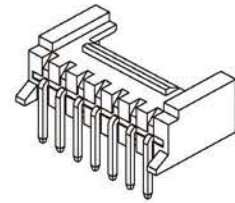

Ordering Information & Dimensions:

Circuit	Dimensions(mm)	
	A	B
02	2.00	6.00
03	4.00	8.00
04	6.00	10.00
05	8.00	12.00
06	10.00	14.00
07	12.00	16.00
08	14.00	18.00
09	16.00	20.00
10	18.00	22.00
11	20.00	24.00
12	22.00	26.00
13	24.00	28.00
14	26.00	30.00
15	28.00	32.00
16	30.00	34.00

A2002Y (2.00mm pitch Housing)

- Reference Information:
 - Material: PA66,UL94V-0(2)
 - Suitable A2002 series terminal
 - Mates with A2002 series Wafer

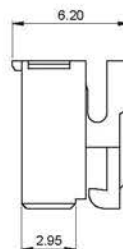
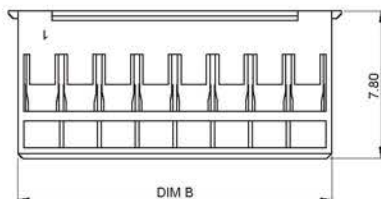
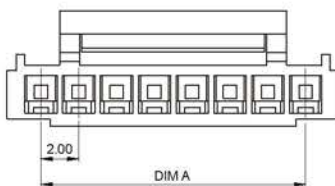
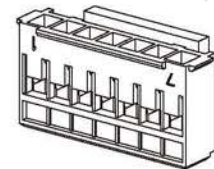

Ordering Information & Dimensions:

Circuit	Dimensions(mm)	
	A	B
02	2.00	4.60
03	4.00	6.60
04	6.00	8.60
05	8.00	10.60
06	10.00	12.60
07	12.00	14.60
08	14.00	16.60
09	16.00	18.60
10	18.00	20.60
11	20.00	22.60
12	22.00	24.60
13	24.00	26.60
14	26.00	28.60
15	28.00	30.60
16	30.00	32.60

WIRE TO BOARD

BOARD TO BOARD

WIRE TO WIRE

FPC SERIES

THR SERIES

LIGHTING SERIES

OTHER SERIES

A2002 SERIES

2.00mm pitch wire to board connector

A2002T (2.00mm pitch Terminal)

■ Reference Information:

Used in A2002 series Housing

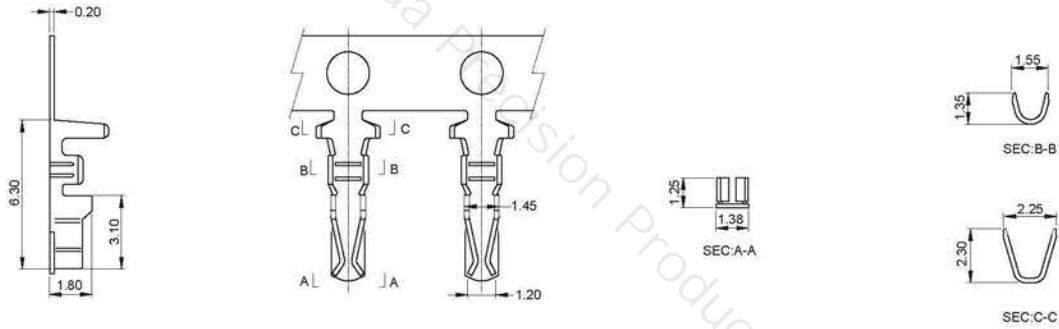

Ordering Information & Dimensions:

Part No	Wire Range	Insulation O.D.	Material	Finish	Qty/Reel
A2002T	AWG #22~#30	1.60mm(max)	Phosphor bronze	Tin-plated	12000PCS