

# HSF RoHS

REV	ECN NO	DESCRIPTION	DATE	NAME
A		NEW		

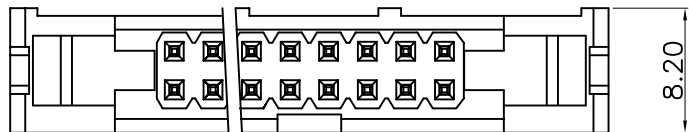

8.20

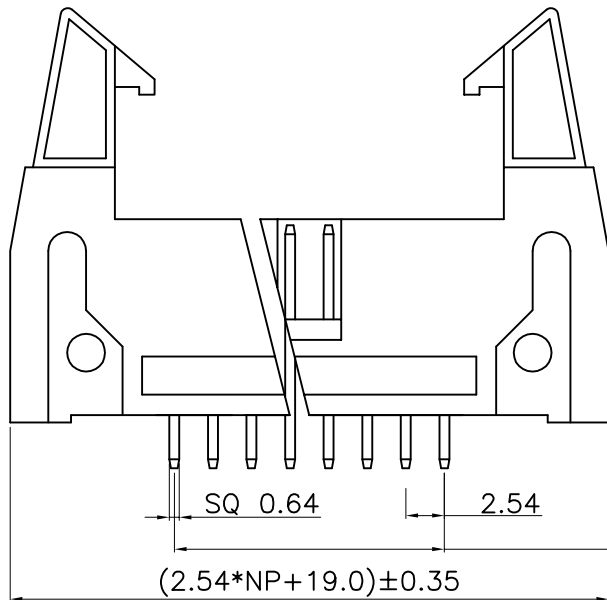

SQ 0.64

2.54

$(2.54 * NP + 19.0) \pm 0.35$

$(2.54 * NP - 2.54) \pm 0.2$

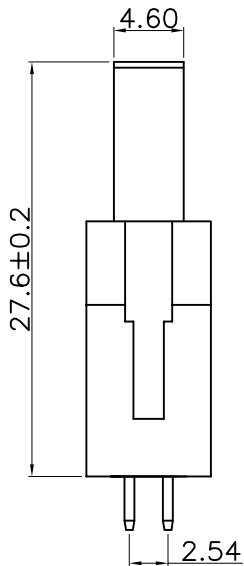

4.60

27.6±0.2

2.54

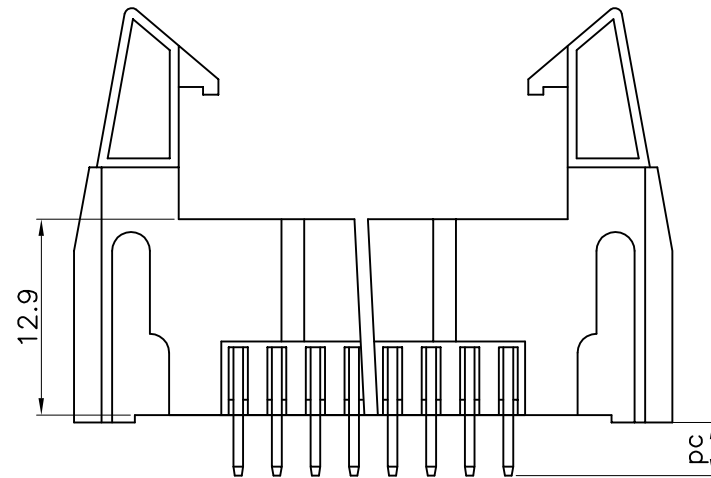

12.9

PC

### 1. MATERIALS AND FINISH

- 1.1 HOUSING MATERIALS: Asfollows
- 1.2 CONTACTS: Brass
- 1.3 PLATING: Asfollows

### 2. SPECIFICATIONS

- 2.1 CURRENT RATING: 3AMP
- 2.2 INSULATION RESISTANCE: 1000MΩ
- 2.3 DIELECTRIC WITHSTANDING VOLTAGE: 1000V AC/DC.
- 2.4 OPERATING TEMPERATURE: -40°C TO +105°C.

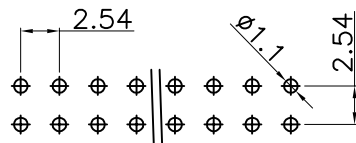
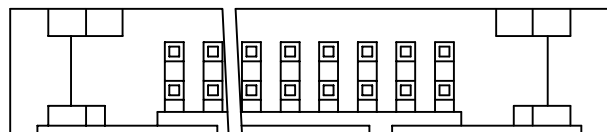

2.54

0.1

2.54

PCB LAYOUT

## Ordering Information

L241XX -XX 0 X X XX X

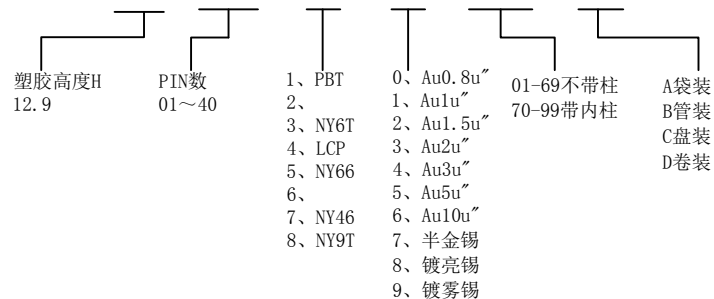

**LDCONN 东莞连大精密制品有限公司**

连大

DongGuan LianDa Precision Products Co., LTD

TITLE	2.54 Ejector Header Straight Type	DRAWN BY	ZSL	18.08.20
PART NO	L241XX-XX0XXXXX	CHECKED BY		
DRAWING NO		APPROVED BY		
SCALE	1:1	UNIT	mm	PAGE 1/1
				SIZE A4

STANDARD TOLERANCE  
(EXCEPT SPECIFIED)

LINER	ANGLES
.0 ±0.30	0.° ±3°
.00 ±0.20	.0° ±2°
.000 ±0.10	.00° ±1°